

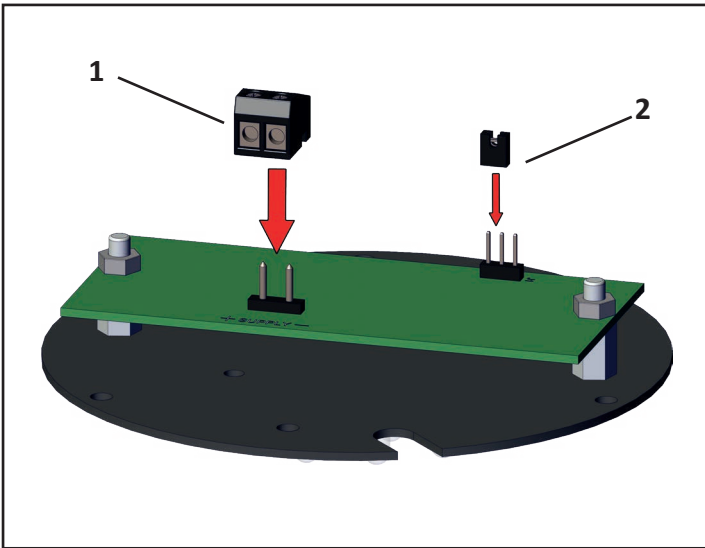

PSU/LED Pulsed LED Beacon

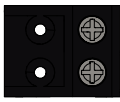

1

	PSU/DC/18-40/LED	PSU/UC/115-230/LED
	-ve (0V)	N
	+ve (18V - 40V dc)	P (98V - 264V ac/dc)

2

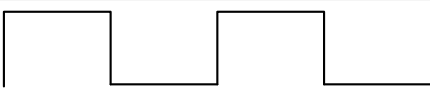
	J1	PATTERN
	0	
	1	